

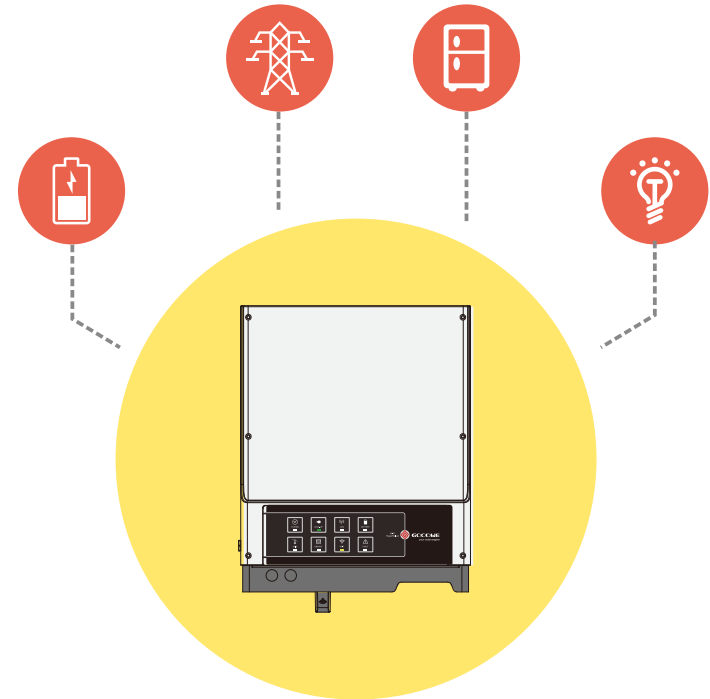

QR Code For  
Andriod System



QR Code For  
iOS System



## S-BP QUICK INSTALLATION INSTRUCTIONS

**PART 1**

**QUICK  
INSTALLATION**

**PART 2**

**BATTERY  
CONNECTION**

**PART 3**

**WI-FI  
CONFIGURATION**

## Step 1. Instructions For Quick Installation

### A Installation Space

Upward -----300mm  
Downward -----500mm  
Front -----300mm  
Left and right side -----200mm

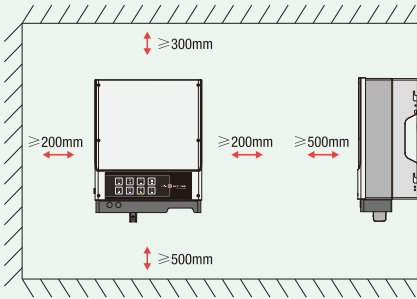

### B Dimensions For Drilling Holes

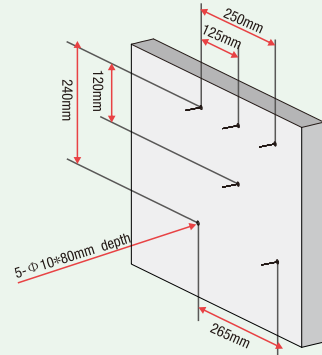

### C Fix the Wall Bracket

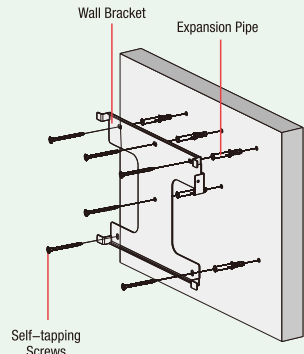

### D Installation

Inverter could be locked for anti-theft, if it is needed.

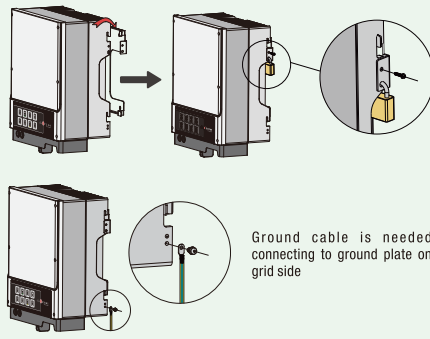

### E Battery Wire Assembly and Connection



Description	Size
A External diameter of the wire	10~12mm
B Sectional area of conducting materials	20~25mm <sup>2</sup>
C Length of bare wire	Approx.10mm

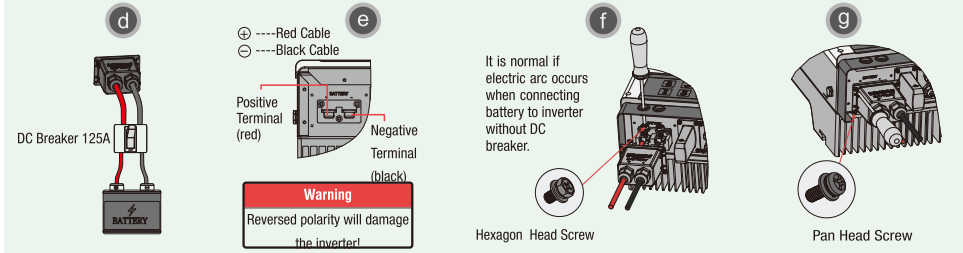
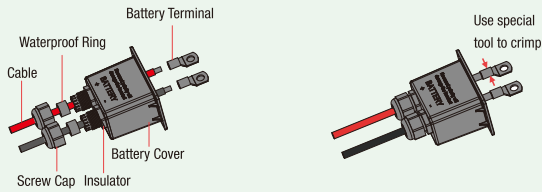

### F AC Cable Assembly and Connection

AC Cable: 6mm<sup>2</sup> Copper Conductor Material

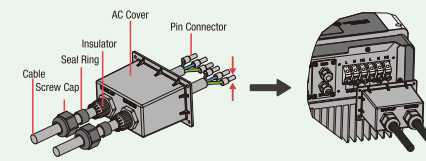

Note: Make sure the cables (L/N/PE) are connected to right position

### G Communication Cable Connection

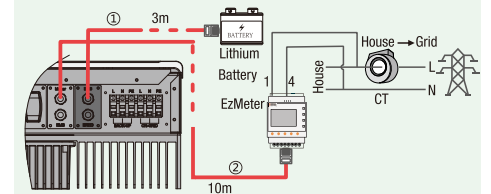

Note: ① To Battery communication cable (Only for lithium battery)  
② To EzMeter communication cable (could be extend to max 100m)

### 3-Phase EzMeter Wiring

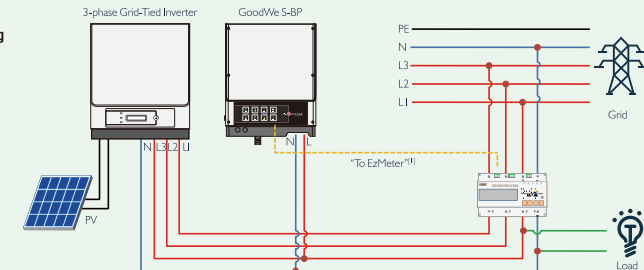

Note: ① For 3-phase EzMeter, L1/L2/L3 is connect to inverter side and L1'/L2'/L3' connected to grid side  
② To connect a 3-phase EzMeter from GoodWe, the external RJ45 plug from "To EzMeter" cable should be cut off, then green and brown pins connect together to port 7, Green & White and Brown & White pins connect together to port 8

### H DRED Cable Assembly

⚠ DRED connection is only available for Australia and New Zealand.

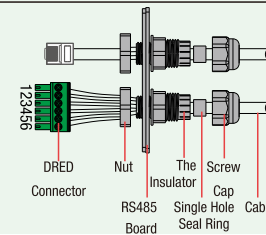

NO	1	2	3	4	5	6
Function	DRM1/5	DRM2/6	DRM3/7	DRM4/8	REFGEN	COM/DRMO

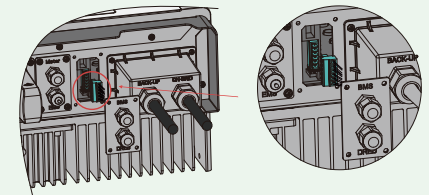

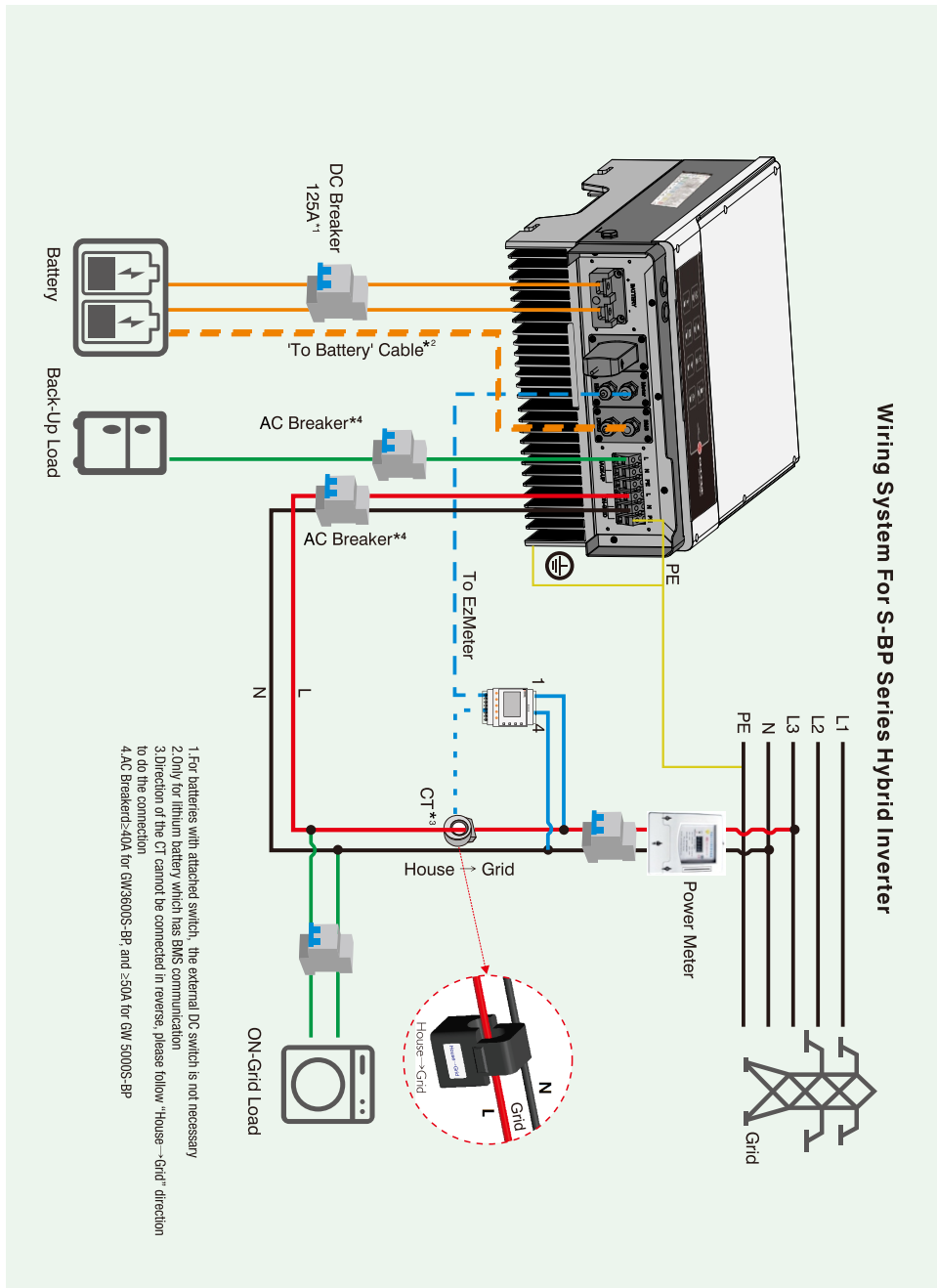

Step 2. SOP of Battery Connection With S-BP Inverter

- BYD
- GCL
- LG
- Pylon

Note: This manual only tells connection methods between battery and GoodWe hybrid inverters. Other operation on battery, please refer to battery user manual.

1. BYD

For BYD B-BOX2.5/5.0/7.5/10/B-Box 13.8 with S-BP Hybrid Inverter

**A** Make sure that the inverter and the battery pack is turned off before connecting the battery pack to the inverter (Refer to Pic.1)

*NOTE:* If connect two or more batteries, the ADDR on each battery must be set differently.

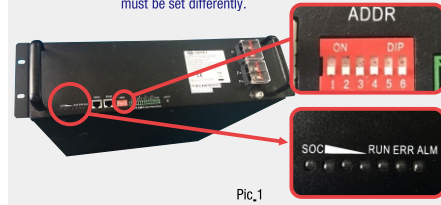

**B** To connect the cables coming from the inverter to the BYD battery pack, take the following steps. Connect the power cables to the terminal block of BYD battery pack. Connect the negative cable to "P-" and the positive cable to "P+." (Refer to Pic.2)

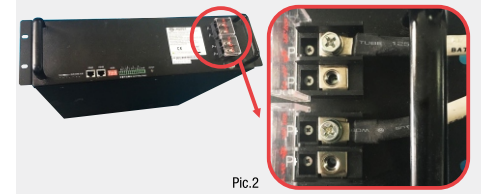

**C** (a) Cut off the plastic skin of the cable.  
 (b) Put the cable through the terminal cover plate.  
 (c) Plug the metal part into the battery R-type terminal (25-8) which in GoodWe accessories box, then crimp the terminal tightly.  
 (d) Connect the power cable to the terminal block of the hybrid inverter and restore the inverter terminal cover plate. (Refer to Pic.3)

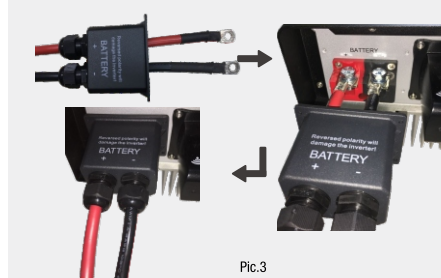

**D** The communication cable for battery is attached on the inverter (Refer to Pic.4). Please use this cable as battery communication cable.

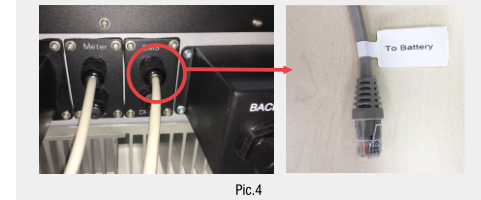

**F** On PV Master, should choose the right battery type used in your system by "Battery Model" selection (Pic. 6) or battery communication will fail.

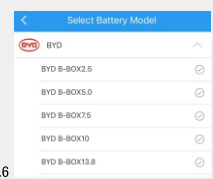

**E** The other side of "To Battery" cable should be connected to CAN port of BYD BMU box (Pic.5).

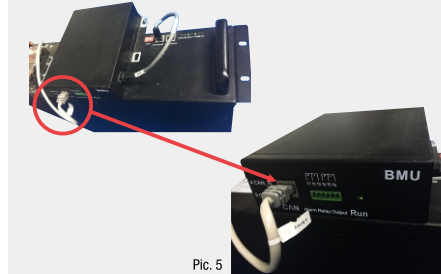

**G** After all connection and settings done, please check if battery communication is OK on PV Master → Param → BMS Status, which should be "Communication OK" (Pic. 7)

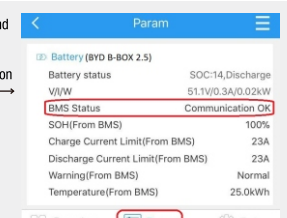

## 2. GCL

For GCL 5.6 KWH / 5.6 KWH\*2 / 5.6 KWH\*3 / 5.6 KWH\*4 with S-BP Hybrid Inverter

**A**  Make sure that the inverter and the battery pack is turned off before connecting the battery pack to the inverter (Refer to Pic.1)

*Note: If connect multi batteries (max 4 pieces), please refer to battery user manual to do configuration on batteries.*

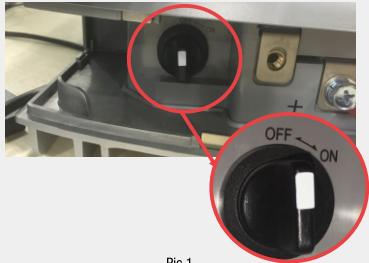

Pic.1

**B** To connect the cables coming from the inverter to the GCL battery pack, take the following steps.  
Connect the power cables to the terminal block of GCL battery pack. Connect the negative cable to "-" and the positive cable to "+". (Refer to Pic.2)



Pic.2

**C** (a) Cut off the plastic skin of the cable.  
(b) Put the cable through the terminal cover plate.  
(c) Plug the metal part into the battery R-type terminal (25-8) which in GoodWe accessories box, then crimp the terminal tightly.  
(d) Connect the power cable to the terminal block of the hybrid inverter and restore the inverter terminal cover plate. (Refer to Pic.3)

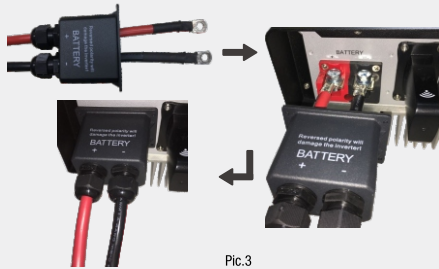

Pic.3

**D** The communication cable for battery is attached on the inverter (Refer to Pic.4)  
Please use this cable as battery communication cable.

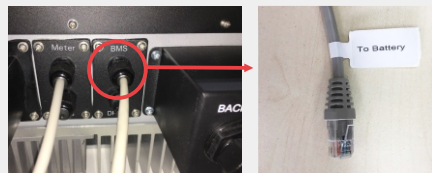

Pic.4

**F** On PV Master, should choose the right battery type used in your system by "Battery Model" selection (Pic. 6) or battery communication will fail.

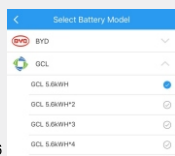

Pic.6

**E** The other side of "To Battery" cable should be connected CAN port of GCL battery (Pic.5)

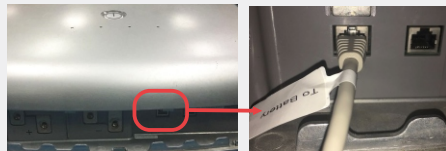

Pic.5

**G** After all connection and settings done, please check if battery communication is OK on PV Master → Param → BMS Status, which should be "Communication OK" (Pic. 7)



Pic. 7

## 3. LG

For LG 6.4/6.5/10 with S-BP Hybrid Inverter.

**A**  Make sure that the inverter and the battery pack is turned off before connecting the battery pack to the inverter (Refer to Pic.1)

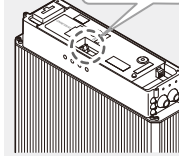

Pic. 1

**B** Remove the top cover. Hold both sides of the top cover and pull it upwards (Refer to Pic.2)

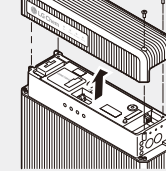

Pic.2

**C** Connect the power cables to the terminal block through the grommet (Refer to Pic.3)  
a) Remove the terminal cover plate, which is placed over the terminal block.  
b) Plug the metal part into the battery R-type terminal (25-8) which in Cable Accessories for LG Battery, then crimp the terminal tightly.  
c) Restore the battery terminal cover plate.

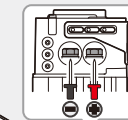

Pic.3

**D** (a) Cut off the plastic skin of the cable.  
(b) Put the cable through the terminal cover plate.  
(c) Plug the metal part into the battery R-type terminal (25-8) which in GoodWe accessories box, then crimp the terminal tightly.  
(d) Connect the power cable to the terminal block of the hybrid inverter and restore the inverter terminal cover plate. (Refer to Pic. 4)



Pic.4

**F** The other side of "To Battery" cable should be connected CAN port on the top side of LG battery (Refer to Pic.6)

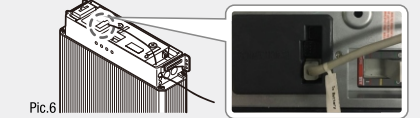

Pic.6

**E** The communication cable for battery is attached on the inverter (Refer to Pic.5)  
Please use this cable as battery communication cable.

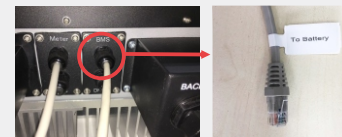

Pic. 5

**H** On PV Master, should choose the right battery type used in your system by "Battery Model" selection (Pic. 8) or battery communication will fail.

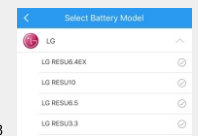

Pic.8

**G** There are three DIP switches and three rotary switches on battery, which should be set as below (Refer to Pic. 7);

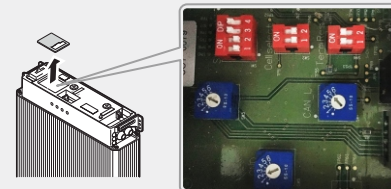

Pic.7

**I** After all connection and settings done, please check if battery communication is OK on PV Master → Param → BMS Status, which should be "Communication OK" (Pic. 9)

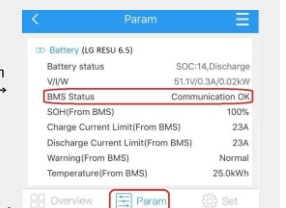

Pic. 9

### 4. Pylon

For Pylon US2000B Series With S-BP Hybrid Inverter.

**A**  Make sure that the inverter and the battery pack is turned off before connecting the battery pack to the inverter (Refer to Pic.1)

**Note:** If connect two or more battery packs, the ADD must set to be different.



Pic.1

**B** To connect the cables coming from the inverter to the Pylon battery pack, take the following steps (Refer to Pic. 2). Connect the negative cable to the black terminal and the positive cable to the orange terminal.



Pic.2

**C** (a) Cut off the plastic skin of the cable.  
 (b) Put the cable through the terminal cover plate.  
 (c) Plug the metal part into the battery R-type terminal (25-8) which in GoodWe accessories box, then crimp the terminal tightly.  
 (d) Connect the power cable to the terminal block of the hybrid inverter and restore the inverter terminal cover plate. (Refer to Pic. 3)

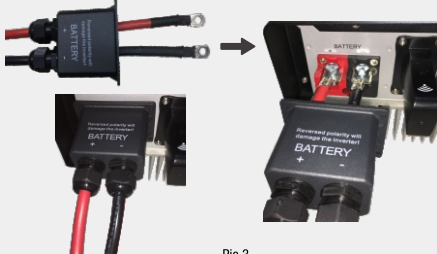

Pic.3

**D** The communication cable for battery is attached on the inverter( Refer to Pic.4) Please use this cable as battery communication cable.

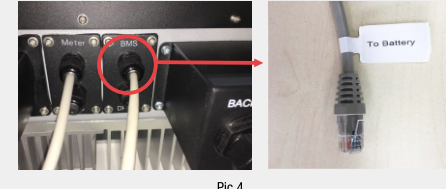

Pic.4

**F** On PV Master, should choose the right battery type used in your system by "Battery Model" selection (Pic. 6) or battery communication will fail.



Pic.6

**E** The other side of "To Battery " cable should be connected CAN port of Pylon battery (Pic. 5)



Pic.5

**G** After all connection and settings done, please check if battery communication is OK on PV Master → Param → BMS Status, which should be "Communication OK" (Pic. 7)



Pic.7

### Step 3. Wi-Fi Conguration Instruction

Note:Wi-Fi Configuration could also be done on PV Master APP, for details, please download "PV Master Operation Introduction" from www.goodwe.com

**A Preparation**

1. Power Wi-Fi inverter (or Power on Inverter) on.
2. Power router on.

**C Preparation**

1. Click 'Start Setup'

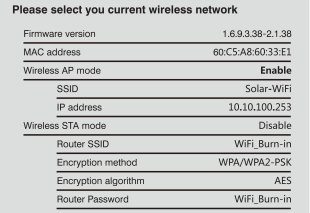

**Please select you current wireless network**

Firmware version 1.6.9.3.38-2.1.38  
 MAC address 60:C5:A8:60:33:E1  
 Wireless AP mode Enable  
 SSID Solar-WiFi  
 IP address 10.10.100.253  
 Wireless STA mode Disable  
 Router SSID WiFi\_Burn-in  
 Encryption method WPA/WPA2-PSK  
 Encryption algorithm AES  
 Router Password WiFi\_Burn-in

**Please select you current wireless network**  
 router doesn't exist, or signal is too weak, or password is incorrect.  
 \*Help: Wizard will help you to complete setting within one minute.

Start Setup

The Wi-Fi module parameters please refer to 'Device information' column above.

**Please select you current wireless network**

SSID	Sec mode	Enc type	Channel	RSSI
WiFi-Test	WPA2-PSK	AES	06	54%

\*Note: When RSSI of the selected Wi-Fi network is lower than 15%, the connection may be unstable, please select other available network or shorten the distance between the device and router. If you wireless router does not broadcast SSID, please click 'Next' and add a wireless network manually.

Back Next

If the router is not in the site list, please refer to No.4 in 'Troubleshooting'.

**E Troubleshooting**

No.	Problem	Checking Items
1	Cannot Find Solar-WiFi Signal	1. Make sure inverter is powered on; 2. Move your smart device closer to inverter; 3. Restart inverter; 4. Do 'WiFi Reload' operation refer to user manual.
2	Cannot connect to Solar-WiFiSignal	1. Try password: 12345678; 2. Restart inverter; 3. Make sure there is no other device connected to Solar-WiFi; 4. Do 'WiFi Reload' operation and try again.
3	Cannot login website 10.10.100.253	1. Make sure user name and password you use are both admin; 2. Do 'WiFi Reload' operation and try again; 3. Try another browser (suggest use Google, FireFox, IE, Safari etc.); 4. Make sure website you log in is 10.10.100.253
4	Cannot find router SSID	1. Move router closer to inverter or use a Wi-Fi repeater device; 2. Connect to router and login the setting page to check the channel it uses. Please make sure the channel is not bigger than 13. Otherwise, modify it.

**B Connect to 'Solar-WiFi'**

1. Wi-Fi name: Solar-Wi-Fi or Solar-WiFi \*( \* means the last 8 characters of inverter serial NO.)  
Password: 12345678
2. Browse website: 10.10.100.253

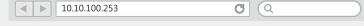

B-3: Enter User name:admin,Password:admin,click OK

Admin(U) : admin  
 Password : \*\*\*\*\*  
 Remember the password(B)

OK CANCEL

**D Connect to 'Solar-WiFi'**

1. Fill in router password and click 'Next'

Add wireless network manually:

Network name (SSID) WiFi-Test  
 Encryption method WAP/WPA2-PSK  
 Encryption algorithm AES

Please enter the wireless network password:

Password (8-63 bytes) hellogoodwe  
 Remember the password(B)

\*Note: case sensitive for SSID and Password.  
 Please make sure all parameters of wireless network are matched with router, including password.

Back Next

Please make sure all parameters of wireless network are matched with the router's, including password.

**Save success!**

Click 'Complete', the current configuration will take effect after restart.

If you still need to configure the other pages of information, please go to complete your required configuration.

Configuration is completed, you can log on the Management page to restart device by click on 'OK' button.

Confirm or complete?  
 Back Complete

Note: The 'Solar-WiFi' signal will disappear after inverter connects to WiFi router. Turn off router or do Wi-Fi reload operation via button on inverter if you need connect to 'Solar-WiFi' once again.

No.	Problem	Checking Items
5	Cannot Find Solar-WiFi Signal	1. Restart inverter 2. Connect to Solar-WiFi and login again, check the 'SSID', 'Security Mode', 'Encryption Type' and 'Pass Phrase' is matching with that of router or not; 3. Connect to router and login to check if the connection reaches the maximum amount or not, and to check the channel of it uses. Please make sure the channel is not bigger than 13. Otherwise, modify it; 4. Restart router ; 5. Move router closer to inverter or use a Wi-Fi repeater device.
6	After configuration, WiFi Led on inverter blink four times repeatedly	1. Connect to the router and visit the portal www.goodwe-power.com. Check the portal is available or not; 2. Restart router and inverter;